



For OCTOPUS Spa

Installation and user's manual

Read carefully and keep it for later reference

WARNING

The disrespect of the instructions of use and maintenance may provoke serious risks for health, in particular that of the children.

The safety of your children is left on your hand! The risk is the highest for children aged below 5. Be high alert all the time.

Keep an eye on and practice the following instructions:

- The children should be under close and constant supervision;
- Designate one security responsible;
- Strengthen supervision if there are several users in the pool;
- Teach your children how to swim as soon as possible;
- Wet the nape, chest and legs before entering the water;
- Learn the safety gestures and especially the specifics to children;
- Prohibit diving and jumping;
- Prohibit running, splashing games around the pool;
- Do not let an unattended child who does not swim use the pool with no life-jackets on;
- Do not leave any players around and in the basin unattended;
- Always keep the water treatment products out of reach of all children.
- Prepare a telephone near the basin so as not to leave your children unattended when you are on phone;

If an accident happened:

- Take the child out the water as soon as possible;
- Call for help at once and follow the instructions that you were given earlier;
- Cover the drown persons with warm blankets

The hot tub's electrical connections must be installed in the electrical safety zones labelled 1, 2 or outside all safety zones. The measured zones are limited by walls and fixed partitions.

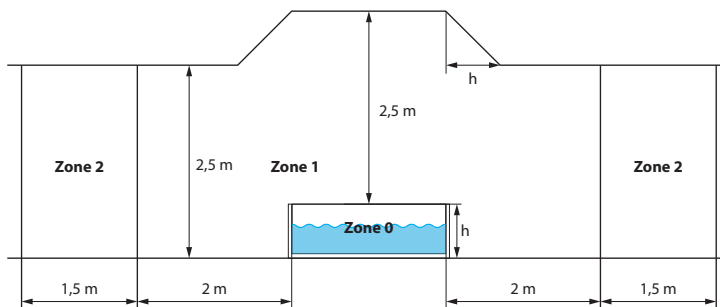

Carefully read, understand, and follow all information in this user manual before installing and using the swimming pool.

These warnings, instructions, and safety guidelines address some common risks of water recreation, but they cannot cover all risks and dangers in all cases. Always use caution, common sense, and good judgment when enjoying any water activity. Please read carefully and keep for future reference.



Non Swimmers safety

1. Continuous, active, and vigilant supervision of weak swimmers and non-swimmers by a competent adult is required at all times (remember that children under five are at the highest risk of drowning)
2. Designate a competent adult to supervise the pool each time it is being used;
3. Weak swimmers or non-swimmers should wear personal protection equipment when using the pool;
4. When the pool is not in use, or unsupervised, remove all toys from the swimming pool and its surrounding to avoid attracting children to the pool.

Safety devices

1. It is recommended to install a barrier (and secure all doors and windows, where applicable) to prevent unauthorized access to the swimming pool;
2. Barriers, pool covers, pool alarms, or similar safety devices are helpful aids, but they are not substitutes for continuous and competent adult supervision.

Safety equipment

1. It is recommended to keep rescue equipment (e.g. a ring buoy) by the pool;
2. Keep a working phone and a list of emergency phone numbers near the pool.

Safe use of the pool

1. Encourage all users especially children to learn how to swim;
2. Learn Basic Life Support (Cardiopulmonary Resuscitation - CPR) and refresh this knowledge regularly. This can make a life-saving difference in the event of an emergency;
3. Instruct all pool users, including children, what to do in case of an emergency;
4. Never dive into any shallow body of water. This can lead to serious injury or death;
5. Do not use the swimming pool when using alcohol or medication that may impair your ability to safely use the pool;
6. When pool covers are used, remove them completely from the water surface before entering the pool;
7. Protect pool occupants from water related illnesses by keeping the pool water treated and practicing good hygiene. Consult the water treatment guidelines in the user's manual;
8. Store chemicals (e.g. water treatment, cleaning or disinfection products) out of the reach of children.
9. Use the signage as outlined below;
10. Removable ladders shall be placed on horizontal surface.

WARNING: drained pool outdoors may cause unknown hazards.

WARNING: Installation and assembly shall be done by adults.

WARNING: Read and follow the the instruction for use and maintenance to ensure a safe use of the swimming pool kit. Not following the instructions for use and maintenance can cause serious health hazards, in particular for children.

WARNING: Only for domestic outdoor use.

WARNING: Drowning hazard. Children have drowned in portable swimming-pools.

WARNING: Empty the pool when not in use. Do not leave a small pool empty outdoor.

WARNING: Keep children under supervision in the aquatic environment.

WARNING: No diving.



IMPORTANT SAFETY INSTRUCTIONS

For your own safety and that of your product, make sure to following the safety precautions below. Fail to follow the instruction may result in serious injury, property damage or death. Improper installation or operation will void the warranty.

Read, understand and follow all instructions:

DANGER

● Risk of accidental drowning:

- Extreme caution must be exercised to prevent unauthorized access by children.
- Inspect the spa cover regularly for leak, premature wear and tear, damage or signs of deterioration. Never use a worn or damaged cover: it will not provide the level of protection required to prevent unsupervised access to the spa by a child.
- Always lock the spa cover after each use.

● Risk of injury:

If the supply cord is damaged, it must be replaced by the manufacturer, its service agent or similarly qualified persons in order to avoid a hazard.

● Risk of Electric Shock:

- Do not permit any electrical appliances, such as a light, telephone, radio or television within 1.5m (5 feet) of a spa tub.
- Do not use the spa when it is raining, thundering or lightning.

WARNING

- To reduce the risk of electric shock, do not use an extension cord, timers, plug adapters or converter plugs to connect the unit to electric supply; provide a properly located outlet.
- The spa electrical appliance should be supplied through a residual current device (RCD) having a rated residual operating current not exceeding 10mA.
- Parts containing live parts, except parts supplied with safety extra-low voltage not exceeding 12V, must be inaccessible to occupants in the spa.
- Parts incorporating electrical components, except remote control devices, must be located or fixed so that they cannot fall into the spa.
- Residential electrical connection box must be located safely with a distance of at least 2m away from the spa.
- Electric installation should fulfil the local requirement or standards.
- This appliance can be used by children aged from 8 years and above and persons with reduced physical, sensory or mental capabilities or lack of experience and knowledge if they have been given supervision or instruction concerning use of the appliance in a safe way and understand the hazards involved. Children shall not play with the appliance. Cleaning and user maintenance shall not be made by children without supervision.
- To reduce the risk or injury, do not permit children use this product unless they are closely supervised all times.
- To reduce the risk of child drowning, supervise children all times. Attach and lock spa cover after each use.
- Make sure the floor is capable of supporting the expected load ($\geq 500\text{kg/m}^2$).
- Adequate draining system must be provided around the spa to deal with overflow water.
- To avoid damage, do not left the appliance empty for an extended period.
- To avoid damage to the pump, the spa must never be operated unless the spa is filled with water.
- Immediately leave spa if uncomfortable or sleepy.
- To reduce the risk of injury :
 - Lower water temperatures are recommended for young children and when spa use exceeds 10 minutes.

In order to avoid the possibility of hyperthermia (heat stress) occurring it is recommended that the average temperature of spa-pool water should not exceed 40°C (104°F).

- Since excessive water temperatures have a high potential for causing fetal damage during the early months of pregnancy, pregnant or possibly pregnant women should limit spa water temperatures to 38°C (100°F).
- Before entering a spa or hot tub the user should measure the water temperature with an accurate thermometer since the tolerance of water temperature regulating devices varies.
- The use of alcohol, drugs or medication before or during spa use may lead to unconsciousness with the possibility of drowning.
- The use of alcohol, drugs, or medication can greatly increase the risk of fatal hyperthermia in spas.

The causes and symptoms of hyperthermia may be described as follows:

Hyperthermia occurs when the internal temperature of body reaches a level several degrees above the normal body temperature 37°C (98.6°F). The symptoms of hyperthermia include an increase in the internal temperature of body, dizziness, lethargy, drowsiness, and fainting. The effect of hyperemia include failure to perceive heat; failure to recognize the need to exit spa; unawareness of impending hazard; fetal damage in pregnant women; physical inability to exit the spa; and unconsciousness resulting in the danger of drowning.

- Obese persons or persons with a history of heart disease, low or high blood pressure, circulatory system problem, or diabetes should consult a physician before using a spa.
- Persons using medication should consult a physician before using a spa since some medication may induce drowsiness while other medication may affect heart rate, blood pressure, and circulation.
- Check with doctor before use if pregnant, diabetic, in poor health, or under medical care.

- People with infectious disease should not use a spa or hot tub.
- To avoid injury exercise care when entering or existing the spa or hot tub.
- Water temperature in excess of 42°C (108°F) may be injurious to your health.
- Never use a spa or hot tub alone or allow others to use the spa alone.
- Do not use a spa or hot tub immediately following strenuous exercise.
- The spa should not be setup or left out in temperature lower than 10°C (50°F).
- Do not put the spa under 0°C (32°F) environment in order to avoid freezing if there is still water in the pool.
- Do not turn on the spa when the water is frozen.
- Never pour water with a temperature higher than 40°C(104°F) into the spa directly.
- Always unplug this product from the electrical outlet before removing, cleaning, servicing or making any adjustment to the product.
- Never jump or dive into a spa or any shallow body of water.
- Do not bury the electrical cord. Locate the cord where it will not be damaged by lawn mowers, hedge trimmers and other equipment.
- Do not attempt to plug in or unplug this product while standing in water or when your hands are wet.
- Do not use the spa if damaged in delivery and/or malfunctioning in any way.
- Keep all pets away from the spa to avoid any damage.
- Do not add bath oil or bath salt to the spa water.
- Do not leave an empty pool outside.
- In order to avoid a hazard due to inadvertent resetting of the thermal cut-out, this appliance must not be supplied through an external switching device, such as a timer, or connected to a circuit that is regularly switched on and off by the utility.

1. SPECIFICATIONS

1.1. Specifications

Model	OCTOPUS 6 persons
Capacity	6 persons
Dimension (outer)	Ø 76" × 27,6" 193 cm × 70 cm
Dimensions (inner)	Ø 65" × 27,6" 165 cm × 70 cm
Water level Max	46 cm
Water capacity	1000 L - 262 gal GB
Power supply	220-240 V / 50 Hz
Heater	2000 W
Air blower	650 W
Filter	1200L/h
Max heat temperature	42°C
Material	PVC
Net weight	36 kg
Gross weight	38 kg
Package dimension	41.8" x 26,4" x 31,9" 106,5 x 67 x 81,5 cm
Test certificate	CE
Heating efficiency Ambient temperature : 20°C	1.5 - 3°C/h



This appliance is marked according to the European directive 2012/19/EU on Waste Electrical and Electronic Equipment (WEEE). This symbol indicates that this appliance may not be treated as household waste. Instead it shall be handed over to the applicable collection point for the recycling of electrical and electronic equipment. Disposal of the appliance shall be carried out in accordance with the local environment regulations for waste disposal.



The CE mark indicates that the product complies with European directives in relation to 2006/95/CE (low voltage), 2004/108/CE (Compliance with the Electromagnetic Compatibility), 2011/65/UE (restriction of the use of certain hazardous substances in electrical and electronic equipment), 2009/125/CE (Ecodesign directive).

2. PACKAGE LIST

2.1. Package list

Ensure to check all parts are present:



8x Foam walls



8 Foam Angles

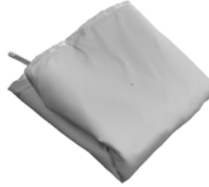

Outer liner



Inner liner



Top cover



Pump unit



Antibacterial filtration
cartridge



cartridge holder



RCD plug 10mA



2x Caps



Fittings for engine
block



Repair kit



3. WARRANTY

3.1. Warranty

NetSpa products have been inspected and found free of defects prior to leaving the factory.

NetSpa warrants this product against defects in material and workmanship for a period of two (2) years.

The warranty period begins on the date of purchase and NetSpa requires presentation of the original proof to purchase to ascertain the date. During the warranty period, NetSpa will either repair or replace, at its discretion, any defective products. Replacement products or repaired parts will be warranted for only the unexpired portion of the original warranty.

Shipping cost policy

The return of defect parts to the authorized service center is at the charge of the owner. On warranty period, the return is at the charge of service center.

Warranty policy

- This limited warranty does not apply to any defect resulting from negligence, accident, misuse, or other reason beyond NetSpa's reasonable control, included but not limited to: normal wear and tear, negligence or failure to follow the product instructions, improper or inadequate maintenance; connection to improper power supply; chemical water damage, loss of pool water, unauthorized product modification or repair; use for commercial purpose; fire, lightening, flood or other external causes.
- This warranty is valid only in the country of purchase in such countries where NetSpa sells and services the same model with identical technical specifications.
- Warranty service outside the country of purchase is limited to the terms and conditions of the corresponding warranty in the country of service. Where the cost of repairs or replacement is not covered by this warranty, NetSpa will advise the owners and the cost shall be charged to the owner.
- This warranty only applies to the original purchaser and terminates upon any transfer of ownership.
- All repairs of which warranty claims are made must be pre-authorized by a NetSpa service center.
- All the authorized selling dealer is responsible for all in-field service work carried out on your NetSpa product. NetSpa will not be liable for results of cost of workmanship from unauthorized service person.

WARNING : Spa installed on inadequately level surfaces are subject to leaking. forming irregularities or collapses. which can result in property damage or serious injury for those in or around the spa area!

CAUTION : Please choose your set-up area carefully as lawn and other desirable vegetation underneath the ground cloth (if applicable) will die. furthermore, try to avoid setting the ground cloth in areas prone to aggressive plant and weed species, as they may grow through the ground cloth.

4.1. Site selection

WARNING : Before proceed to installation your spa, please make sure that the future location meets the following conditions :

- A level place
- Wide enough to support the pool and its pump unit.
- Able to support more than 500 kg/m².
- Sheltered from the sun and bad weather.
- Clean, devoid of roughness and water resistant.

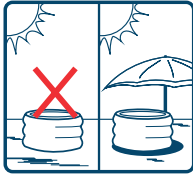

A place with an awning



Clean the place

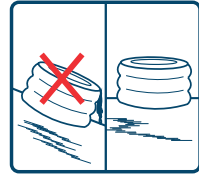

A level place

4.2. RCD test

**WARNING: The RCD plug must be tested before each use..
Do not use if RCD test fails and see chapter 6.1.**



1. Insert the plug into the power outlet.



2. Press the «RESET» button, the indicator light turns red.



3. Press the «TEST» button, the indicator light turns off.



4. Press the «RESET» button, the indicator light turns red. The RCD works properly.

Grounding

You are recommended to use the services of a qualified electrician to ensure that the spa is electrically grounded by using a copper conductor of at least 2.5 mm² cross section.

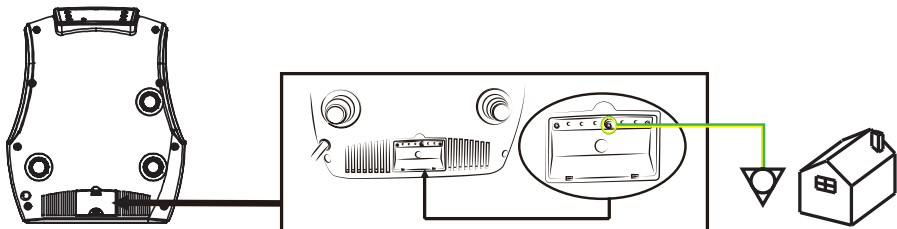

4. INSTALLATION

The number of persons required for installation: 1 adult at least.
15 minutes for site preparation and water filling.

4.3. Assembling



1) Choose a flat and level location.



2) Add the foam wall segment with the three holes in it for connection to the base liner.



3) Add the foam wall segment with the three holes in it for connection to the base liner.

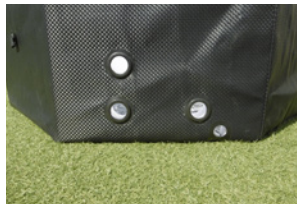

4) Ensure that the three connection holes in the foam wall are aligned with the three connection holes in the outer liner.



5) Add the other foam wall segments.



6) Adjust the 8 segments until they form a perfect round shape. Then, ensure that the holes for the outer liner connection and the holes in the foam wall are still aligned.



7) Insert the inner liner of your spa.



8) Bring the 3 connections of this liner out of the spaces provided for this purpose. The shortest connection is located on the bottom left



9) Add the 8 foam edges to each foam and check that they are properly adjusted.



9) Smooth the liner all around the spa to ensure a good fit.
To facilitate the placement of the last rim, press the foam structure with your knee.



10) Make sure that the zippers of the inner and outer liners are aligned before zipping them up.



11) Smooth the liner all around the spa to ensure a good fit.



12) Locate the place where the two zippers are aligned, connect them and start to zip the two parts together.



13) The two parts must be fully zipped up.



14) Connect the unit pump to the pool using the 3 connectors to screw. Ensure the icons on the pump and the pool match up



15) Remove the 2 caps then put the filter support on the filter cartridge and screw it on the bottom suction connection inside the basin.



16) Check that the drain plug is closed properly.



17) Fill the spa pool until the indicated fill level is reached. Your spa is ready to be used.

4.4. Pool cover and security

After each use, the control panel must be locked and the pool must be coated with its top cover and it must be attached to the base protector with the safety buckles.

Each safety buckles has a lock system ; closed buckle, the latch in up position locks the buckle, the latch in down position unlocks the buckle.

The top cover keeps the heat from the water and secures the pool.



Warning : Do not leave spa unattended while filling with water.

Make sure the drain fitting is plugged securely and the cap is in place. Start filling the spa with water. After about 1-inch of water is on the bottom, stop filling and smooth wrinkles out of the bottom of the spa. Pull the outer wall out from the top edge, all around the bottom of the spa, so that it fills evenly.

Continue filling the spa until water level.

5. USAGE

5.1. Control panel

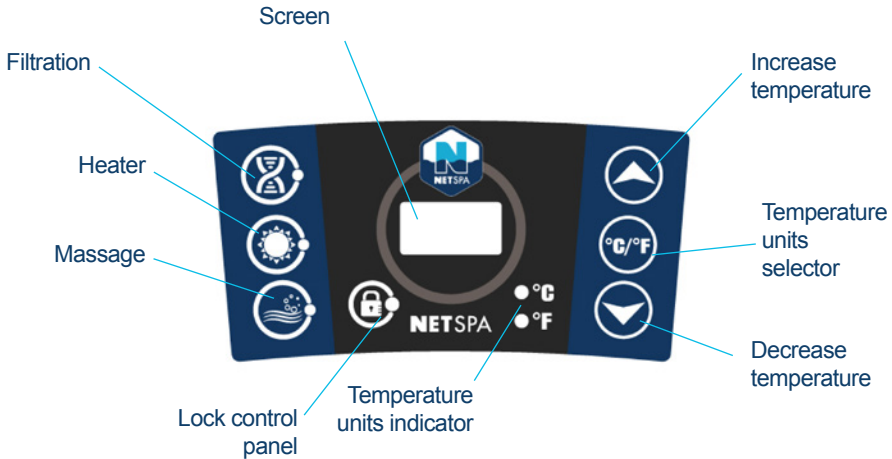

5.2. Functions

Once powered-up, the LED displays the current water temperature automatically.



The temperature units selector changes the temperature units from Celsius degrees to Fahrenheit degrees.



Press the temperature adjustment buttons, then the screen will flash. When it is flashing, you can set the desired temperature. The value will increase or decrease 1 degree at once. The temperature could be set between 30°C to 42°C (86°F to 107°F).



To lock or unlock the control panel, press the Lock button and hold 3 seconds. **Lock the control panel when you are away to prevent other people come to change your settings..**



Press the massage button to activate the bubble massage system, the green indicator light turns on. It can be turned off by pressing it again.

Note :

- The massage system will stop automatically after 30 minutes of operation. Re-activate the massage function by pressing the massage button again.
- When filter button is on, pressing bubble button will exchange filter mode into massage mode: filter indicator light will turn off and massage indicator light turn on. If press the bubble button again, the massage mode will be changed back to filter mode.



Press the filter button to activate the water filtration. The green indicator light will turn on when the filtration system is activated.

Note:

- If massage function is on, the filtration can't be activated.



Press the heating button to activate water heating and filtering system at the same time. The green indicator light of filter and red indicator light of heating will turn on at same time

The pump does not stop heating until the current water temperature reaches the set temperature; and the heating system will restart after the current water temperature drops 2°C below the set temperature automatically.

Maximum heating temperature: 42°C (107°F)

Important :

After 150 cumulative hours of filtration operation, the message "CHG FIL" is displayed on the filter block. This message is an automatic reminder to indicate that it is time to change the filter cartridge.

To delete the message, hold the "filter" button for 5 seconds.

Note :

- The heating system is dependent on the filtration system and it can operate without.*
- After turning off the heating system, the filtration system will still work.*
- If the massage function is active, the filtration and heating functions can be activated.*
- The engine block is designed to operate 24 hours a day.*
- The spa cannot be connected to a programmer because of its electrical protection.*

5.3. Pool cover and security

After each use, the control panel must be locked and the pool must be coated with its top cover and it must be attached to the base protector with the safety buckles.

Each safety buckles has a lock system ; closed buckle, the latch in up position locks the buckle, the latch in down position unlocks the buckle.

The top cover keeps the heat from the water and secures the pool.



6. MAINTENANCE

6.1. Water maintenance

WARNING : A bad pool water quality can harm your health.

Depending on the frequency and conditions of use:

- The filter cartridge should be regularly cleaned (150 hours max.).
- The filter cartridge should be replaced every 1 to 2 month.
- The pool water should be changed every 15 to 30 days.

Use a water test kit to control the parameters of the water before using the spa, or at least once a week.

Use disinfection products for the spa. The treatment products should be used with caution and it is imperative to refer to their instructions.

Damage resulting from improper use of treatment products is not covered by warranty (overdose, shock treatment, ...).

1. Water balance

The water balance (pH) must be maintain between 7 and 7.4.

2. Water Sanitation

To sanitize the pool water, we suggest using an active oxygen-based treatment or bromine placed in a floating dispenser. (Dispenser sold separately).



6.2. Cleaning and replacing filter cartridge

Dirty filter cartridge may contaminate the pool water and cause damage to the heating function.

1. Unscrew the filter case by turning it counter-clockwise. Take out the filter cartridge from the case.
2. Rinse off the filter cartridge with a garden hose. If the filter cartridge remains dirty and discoloured, the filter cartridge should be replaced.
3. Put back the cleaned filter cartridge into his case and screw it to the pool.



6.3. Drainage and storage

Drainage

- 1 Check the stopper on the bottom of the pool and the drain cap.
 - 2 Unscrew the drain cap.
 - 3 Connect the drainage hose.
 - 4 Press the drain valve. Completely drain all water from the spa pool.
- Once empty, the pool can be cleaned with soap and water.



Storage

- 5 Press the bubbling button to blow out the water inside the jet holes. Unplug the pump, remove the filter cartridge from the inner wall of the pool.
- 6 Use a towel to wipe off the pool, dry 24 hours.
- 7 Unscrew the valves to deflate the pool.
- 8 Fold the pool.

It is recommended that store the SPA in its original package in a warm dry place.



6.4. Repair kit

Little holes or puncture can be repaired with the repair kit included and glue reserved to pool liner.

1. Find the leak.
2. Thoroughly clean the area surrounding the leak.
3. Cut a piece of repair material in round shape, which should be larger than the damaged area.
4. Apply adhesive to the underneath side of the patch and around the area to be repaired.
5. Put the patch on the damaged area and press down firmly. Allow 12 hours for repair to dry. After patch has dried, apply glue around the edges for a complete seal (dry 4 hours).

7. TROUBLE SHOOTING

7.1. Troubleshooting

Here are some useful tips to help you to diagnose and rectify common sources of trouble.

Problem	Cause	Solution
Control panel screen does not operate	Check power source	Power failure
		Reset the RCD plug / Check if the wiring system is adapted to the power of the pump unit (1540W)
		Call for service if it does not reset
SPA pump does not heat properly	Temperature set is too low	Set to a higher temperature
	Filter Cartridge is dirty	Clean or Replace the cartridge (see chapter 5.2)
	Too low water level	Fill water to minimum water level
	Heating element defective	Call for service
Bubble massage system does not work	Pump is overheating	Cut off the power and wait until the pump has cooled.
	Auto shut-down feature (30min) is activated	Press the bubble button to reactivate
	Malfunction of the pump unit	Call for service if it does not reset
Water filtration does not work	Filter Cartridge is dirty	Clean or Replace the cartridge (see chapter 5.2)
	Inlet and outlet blocked	Clean the inlet and outlet
	Air inside the pump	Fill water to minimum water level
	Malfunction of the pump unit	Call for service if it does not reset
Pump leakage	Adaptor seal improperly	Replace the seal in the right position
	Water leakage from pump body	Check the pump body, call for service
Spa pool leakage	Spa pool is torn or punctured	Use provided repair kit (see chapter 5.4)
Water is not clean	Insufficient filtering time	Increase the filtering time
	Filter Cartridge is dirty	Clean or Replace the cartridge (see chapter 5.2)
	Pool filled water quality	Change the pool water completely
	Improper water treatment	Refer to the chemical manufacturer's instructions



IMPORTANT

Do not return the product to the store

Contact your local after sales service
on www.netspa.eu or **POOLSTAR FRANCE**

7. TROUBLE SHOOTING

7.2. Error code

If the screen displays an error code “Ex”, please refer to the table below.

Code	Situation	Problem	Causes	Solutions
E1	Not heating Not heating properly.	Wrong temperature control sensor.	Temperature control sensor short circuit or open circuit.	Contact NetSpa service center.
E2	Not heating properly.	Wrong temperature control sensor.	Temperature control sensor short circuit or open circuit.	Contact NetSpa service center.
E3	Not heating properly.	High water temperature indicator.	The filled water is over 47°C (117°F).	<ul style="list-style-type: none"> · Cut off the power, make sure the pool water is between 2°C~44°C (36°F~111°F) · If this does not solve the problem, refer to the box below
E4	All functions do not work, buzzing warn.	Low water temperature indicator.	The pool water is lower than 4°C (40°F).	<ul style="list-style-type: none"> · Cut off the power, make sure the pool water is between 2°C~44°C (36°F~111°F) · If this does not solve the problem, refer to the box below
E5	All functions do not work, buzzing warn.	High water temperature indicator.	The filled water is over 50°C (122°F).	<ul style="list-style-type: none"> · Cut off the power, turn to qualified electrician to reset the thermal cutout described in next paragraph. · If this does not solve the problem, refer to the box below
E6	Not heating and filtering properly. Buzzing warns.	Water pressure is not big enough to activate heating.	<ul style="list-style-type: none"> · Inlet or outlet on inner wall are blocked. · Filter cartridge is too dirty. · Pool water does not reach minimum water level. · Do not release air from pump Pump is wrong" 	<ul style="list-style-type: none"> · Clean inlet and outlet · Clean or replace filter cartridge · Add water to reach water level · Do air release as outlined again · If this does not solve the problem, refer to the box below
E7	All functions do not work, buzzing warn.	Dry-run heater.	Heating at no water situation, system shut down automatically	<ul style="list-style-type: none"> · If this does not solve the problem, refer to the box below
CHG FIL		The screen displays CHG FIL	The filter has spent 150 hours of use	Change the filter and press the filter button for 5s

E3, E4, E5, E6 and E7 error code

- Cut off electricity for 5 minutes and reconnect.

If error code is still displayed on the control Box, please do the following instructions :

1 - Check that the water line is between the high and low limits.

2 - Clean or replace the filter cartridge.

3 - Unscrew and clean the 2 nozzles (Entry and exit of water) inside the spa and remove wastes if necessary (Neaf, hairs, fur, skin...)

4 - Check that the propeller of the filter pump does not contain foreign matter.

Cut the spa again electrically for 5 minutes and re-connect it, if the error code is still displayed on the control box please contact the NetSpa Service Center.

7. TROUBLE SHOOTING

7.3. Return procedure

In case of malfunction, please contact the customer service center NetSpa by connecting to the following address: <http://support.netspa.eu>

After verifying your information, and an online diagnosis of your spa one of our representatives will contact you to provide you indicated the procedure.

If necessary, we will ask you to return the pump unit of your spa for a complete diagnosis and repair.



1) Disconnect the spa



2) Do not empty the pool by screwing the caps inside the pool



3) Unscrew the three connectors from the pump unit.



4) Empty the remaining water within the pump unit.



5) Pack appropriately the pump unit in its original packaging including your return authorization.



6) Ship the pump unit.



7) After a complete diagnosis in our center, you will receive the replacement pump unit.



8) Connect the unit pump to the pool using the 3 connectors to screw. Ensure the icons on the pump and the pool match up



9) Unscrew the caps inside the pool. Your spa is ready to be used.